

浙江金纬片板膜设备制造有限公司
ZHEJIANG JWELL SHEET&FILM EQUIPMENT CO.,LTD.

金纬机械 浙江厂区

地址：中国 浙江省 嘉兴市 海宁斜桥工业园 庆丰路128号
电话：0573-8778 6088 / +86 13917612260 (微信同号)
邮箱：salcc@jwell.cn / sales@jwell.cn
投诉邮箱：info@jwell.cn
网址：www.jwellhn.com / www. jwell.cn

JWELL MACHINERY ZHEJIANG FACTORY

Add:No.128, Qingfeng Road, Xieqiao Industrial Zone, Haining City, Zhejiang, China
Tel:+86-573-8778 6088 / +86 13917612260 (Whatsapp)
E-mail: salcc@jwell.cn / sales@jwell.cn
Complaint E-mail:info@jwell.cn
Web Site: www.jwellhn.com / www. jwell.cn



www. jwell.cn



www. jwell.cn

SHEET & PLATE

EXTRUSION LINE

片板类生产线

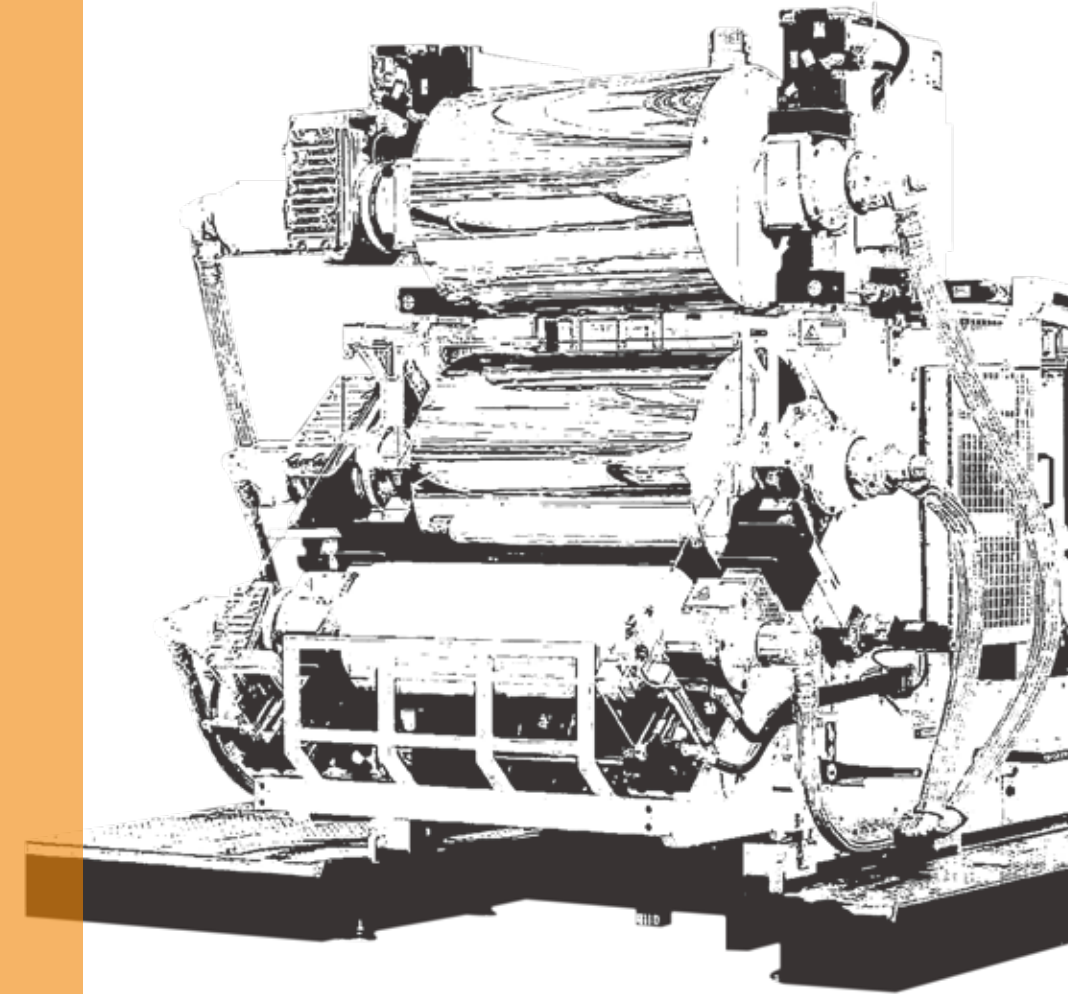

No.2022.06.S&P

浙江金纬片板膜设备制造有限公司
ZHEJIANG JWELL SHEET & FILM EQUIPMENT CO.,LTD.



A Global Supplier of Complete Solutions on Extrusion Technology
 金纬机械—全球挤出技术 整体解决方案供应商

10+ 驻海外办事处 Overseas offices
 580+ 技术研发&工程师 R&D Engineer
 3,000+ 金纬机械员工人数 Jwell Employee
 8+ 个制造基地 Manufacture Bases
 500+ 独家专利技术 Patents
 1,000,000m²+ 工厂面积 Plant Area



80年代初

金海螺第一代螺杆研制成功
 In the early 1980s, the first generation screw of JINHAILUO was successfully developed

1997

上海金纬机械
 Shanghai JWELL Machinery

2008

苏州金纬机械
 Suzhou JWELL Machinery

2012

常州金纬机械
 Changzhou JWELL Machinery

2018

贝克威尔 (泰国)
 Bkwell (Thailand)

2019

浙江金纬智能装备
 Zhejiang JWELL Machinery

2020

金纬公司业绩突破50亿人民币
 Jwell's annual sales exceeded CNY 5 billion

2021

滁州金纬机械
 Chuzhou JWELL Machinery

2022

连续11年荣获中国塑料机械挤出行业排名首位
 Ranked first in China's plastic machinery extrusion industry for 11 consecutive years

We Know Extrusion

ZHEJIANG JWELL SHEET & FILM EQUIPMENT

浙江金纬片板膜设备制造有限公司是金纬机械旗下的又一个重要发展战略中心和制造基地，位于浙江省海宁市斜桥工业园区。一期用地115亩，厂区内配套有先进的零部件CNC机械加工基地和规范的装配车间，年产800套塑料挤出智能装备。公司专注于塑料片板膜挤出装备制造和全方位的专业技术服务，用心制造符合全球中高端用户所需的塑料挤出设备。严谨的设计、严格的标准化制造过程、完善的售后服务保障体系，为用户提供高效、节能、品质卓越的生产线设备和贴心的服务。

Zhejiang Jwell Sheet & Film Equipment Co.,Ltd is one more important strategic center and production base of JWELL Group. It is located in XIEQIAO Industrial zone of Haining city, Zhejiang Province. The 1st company infrastructure is designed for 76,500 square meters factory, this new factory are equipped with a lot of advanced CNC machining centers and well-organized assembling workshops. Every year, there will be more than 800 intelligent extrusion equipments manufactured from this production base. Zhejiang Jwell Sheet & Film Equipment Co.,Ltd focus on manufacturing Sheet & Film extrusion equipments, complete and professional technical service, we are dedicated to offering Customized extrusion equipments for our global customers. Rigorous technical design, Strict and standard production process, complete after-sale service and maintenance system, ZHEJIANG JWELL is providing high-efficiency, energy-saving, outstanding-quality extrusion equipment and caring service to our customers.



公司产品已遍布全国各地，并出口到俄罗斯、印度、韩国、印尼、中东、非洲和南美洲、西班牙、意大利等100多个国家和地区，深受客户好评。

JWELL and Jinhailuo are famous brands in Chinese plastic machinery industry.

JWELL machinery has been sold across the country, and exported to all continents over the world, including the market of developed country, such as Germany, America, Japan, Spain and so on.

“品质卓越 完美如一”

是金纬公司的质量方针，是全体员工努力的方向。

“诚实待人”

是我们铸就“百年金纬”的核心理念。

董事长：何海潮 Email: he@jwell.cn

"Excellent Quality, Perfect All" is Jwell's quality policy, and all staff's working direction.

"Be honest" is the core idea for us to contribute "Century JWELL"

President: He Haichao Mobile/WhatsApp +86 13601628188



APET/PETG单螺杆片材生产线 APET/PETG Single Screw Sheet Extrusion Line

APET、PETG单层及多层共挤片材生产线

是目前国内技术先进、工艺成熟、设备稳定的片材生产线之一，与国内同类设备相比，综合效能高30%以上，此生产线同时也可用于生产 APET、PETG、CPET 等片材制品。

APET, PETG single-layer or multi-layer sheet extrusion machine

It's one of the most advanced production lines with matured technology and stability in China. Compared with other same kind equipment, it's over 30% higher in overall efficiency. This line is suitable for APET, PETG, CPET as well.

PETG片材 PETG sheet

PETG俗称低温PET，产品具有高光泽、高透明、有优良的阻隔性、自粘性的新型环保包装材料。可用于胶水粘合、高周波加工。

PETG is called low temperature PET

It's a new environment-friendly packing material with features such as high luster, good transparency, excellent barrier property, self-adhesion, which is used for glue bonding and high-frequency processing.

PET立体光栅片 PET

广泛适用于化妆品、药品、烟酒包装及一般商品等三维防伪外包装以及文具、挂件、宣传广告、海报、各式卡片、吊卡等领域。

Stereoscopic optical grating sheet

It can be used as top grade package for cosmetics, medicine, tobacco & alcohol and common goods such as stationery, advertisements, posters and all kinds of cards.

PLA片材 PLA sheet

聚乳酸PLA是可降解树脂，可用于水果、蔬菜、鸡蛋、熟食和烘烤食品的硬包装，也可用于三明治、饼干和鲜花等商品的包装。

PLA is a kind of line shape Aliphatic Polyesters. PLA can be used in rigid package of fruits, vegetables, eggs, cooked food and roast food, also can be used for packaging of sandwich, biscuit and some other packages like fresh flower.



主要技术参数 Main technical parameters

机型 Model	共挤线 Multi layer	单层线 Single layer	高效 Highly-efficient
挤出机规格 Extruder specification	JW120/65-1000	JW120-1000	JW150-1500
制品厚度 Thickness of the product	0.20-1.5mm	0.2-1.5mm	0.2-1.5mm
主电机功率 Main motor power	132kw/45kw	132kw	200kw
最大挤出产量 Max extrusion capacity	600-700kg/h	550-650kg/h	800-1000kg/h

备注：以上规格参数如有变更，恕不另行通知。Note: The specifications are subject to change without prior notice.

双螺杆免干燥排气型PET/PLA片材生产线 Twin Screw Dryer-free Vented PET/PLA Sheet Extrusion Line

金纬机械推出的双螺杆免干燥排气型PET片材生产线具有低能耗、工艺简单，设备使用维护方便的特点。其特有的螺杆组合结构有效的减少了PET树脂的粘度降，对称式薄壁型辊筒提高了冷却效率同时提升了产能和片材品质，多组分喂料装置可合理的控制新料、回料、色母等的比例，所生产的片材可用于吸塑印刷包装等领域。

JWELL develops the parallel twin screw extrusion line for PET sheet, this line equipped with degassing system, and no need drying and crystallizing unit. The extrusion line has the properties of low energy consumption, simple production process and easy maintenance. The segmented screw structure can reduce the viscosity loss of PET resin, the symmetrical and thin-wall calender roller heighten the cooling effect and improve the capacity and sheet quality. Multi components dosing feeder can control the percentage of virgin material, recycling material and master batch precisely, the sheet is widely used for thermo-forming packaging industry.



主要技术参数 Main technical parameters

机型 Model	共挤线 Multi layer	单层线 Single layer	高效 Highly-efficient
挤出机规格 Extruder specification	JW75&36/40-1000	JW75/40-1000	JW95&52/44-1500
制品厚度 Thickness of the product	0.15-1.5mm	0.15-1.5mm	0.15-1.5mm
主电机功率 Main motor power	110kw/45kw	110kw	250kw/55kw
最大挤出产量 Max extrusion capacity	500kg/h	450kg/h	800-1000kg/h

备注：以上规格参数如有变更，恕不另行通知。Note: The specifications are subject to change without prior notice.

PP/PS环保片材生产线 PP/PS Environmental Sheet Extrusion Line

金纬机械研制开发的PP/PS片材生产线，用于生产多层复合环保片材，该片材主要用于吸塑成型各类食品容器和包装，如：托盘、面碗、饭盒、糕盒、水果盘等。该设备可有效的利用石粉比例，既降低片材原料成本，又提高片材的可降解性并保证片材的综合物理性能和后续可加工性能。

Developed by JWELL, this line is for producing multi-layer environmental-friendly sheet, which is widely used for vacuum forming, green food container and package, different kinds of food packaging container, such as: salver, bowl, canteen, fruit dish, etc. Adopting maximum talc percentage in the sheet production, either customer will be able to reduce the cost of the sheet or increase the sheet degraation character as well as gaining good physical properties and further processing abilities.



主要技术参数 Main technical parameters

机型 Model	JWS150/120/90-1800	JWS150/60-1200	JWS130/60-1000	JWS120-1000	JWS100-800
片材宽度 Width	1500mm	1000mm	900mm	800mm	600mm
片材厚度 Thickness	0.3-2mm	0.3-2mm	0.3-2mm	0.2-2mm	0.1-0.8mm
生产能力 Capacity	1000-1200kg/h	700-800kg/h	550-600kg/h	400-500kg/h	300-350kg/h

备注：以上规格参数如有变更，恕不另行通知。Note:The specifications are subject to change without prior notice.

PP/EVA/EVOH/PS/PE多层共挤阻隔片材生产线 PP/EVA/EVOH/PS and PE Multi-Layer Sheet Co-Extrusion Line

PP、EVA、EVOH、PS、PE多层共挤阻隔片材生产线

由于市场对产品越来越苛刻的要求，金纬机械开发了先进的五层对称和七层非对称分配技术，使该设备生产出的产品获得了更优异的阻隔性能。

PP, EVA, EVOH, PS and PE multi-layer sheet co-extrusion line

To meet market's high request on products, JWELL develops advanced technology of five layer symmetrical distribution and seven layer asymmetrical distribution, which makes the sheets having better barrier performance.

PP/EVA/EVOH/EVA/PP五层或七层共挤复合高阻隔保鲜包装材料

是具有良好的阻气性、阻湿性，是气体阻隔性能良好的一种塑料包装材料。主要应用于果冻包装，高档肉食品、快餐米饭等食品包装，药品、化妆品等包装。

PP/EVA/EVOH/EVA/PP five or seven multi-layer co-extrusion high barrier fresh keeping sheet

Has the excellent anti-oxygen and anti-humidity features. It is one of the best barrier packing materials. Mainly used for Jelly packing, meat packing, snack food packing, medicine and cosmetic packing and so on.

主要技术参数 Main technical parameters

机型 Model	JW100/45/45-1000	JW120/45/30/65-1200	JW150/45/45-1500
适用原料 Suitable material	PP、PE、PET、PS		
片材宽度 Width	800mm	1000mm	1200mm
片材厚度 Thickness	0.5-2mm	0.5-2mm	0.5-2mm
生产能力 Capacity	300kg/h	400kg/h	650kg/h
设计线速度 Designed line speed	15m/min	20m/min	30m/min
辊筒直径 Calendar diameter	Ø400mm	Ø500mm	Ø600mm

备注：以上规格参数如有变更，恕不另行通知。Note: The specifications are subject to change without prior notice.

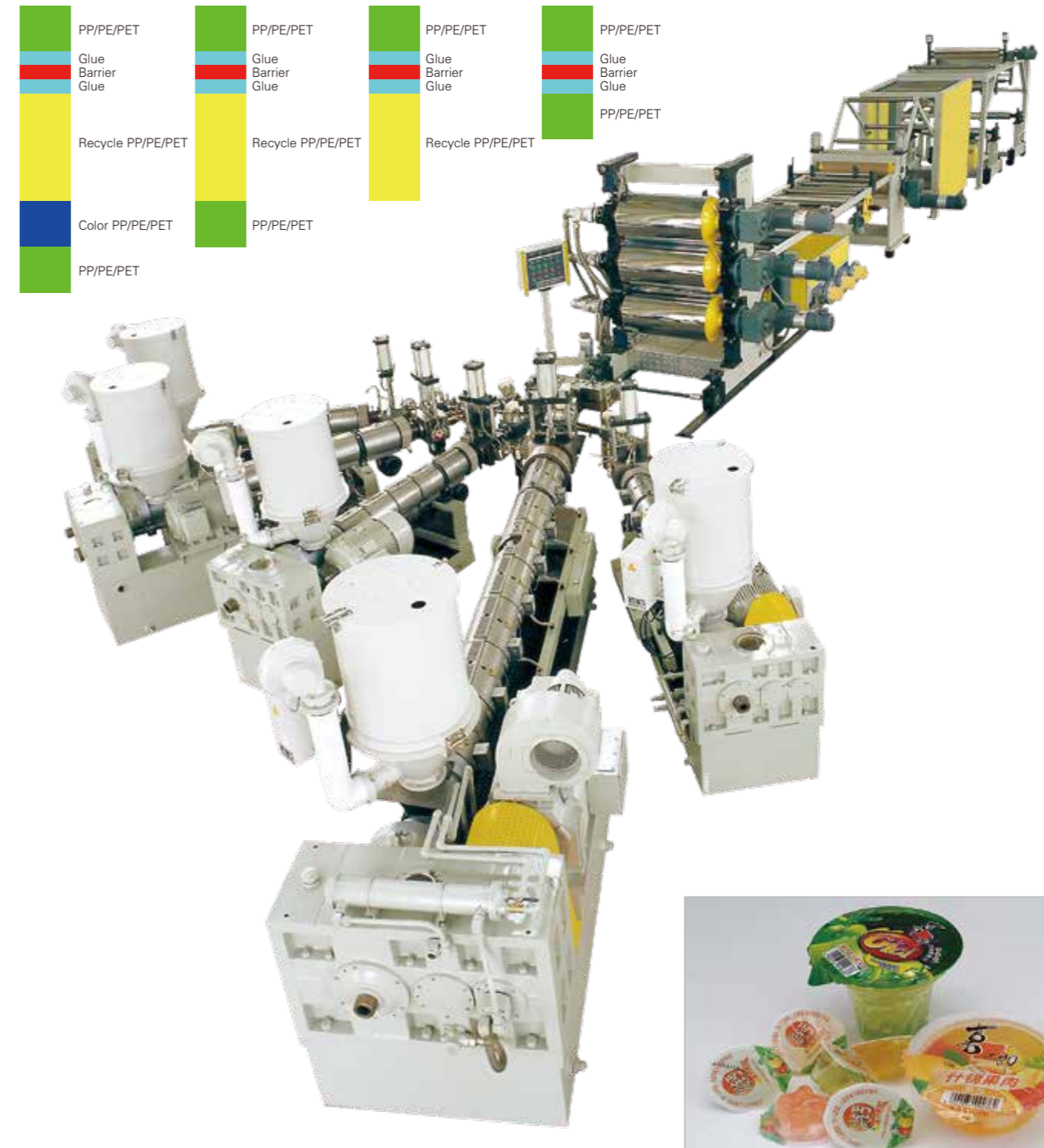

PC/PMMA光学片材生产线 PC/PMMA Optic Sheet Extrusion Line

PC/PMMA光学片材生产线为了满足市场的需要，金纬机械凭借先进的工艺技术及装备向用户提供了光学级片材生产线。根据原料的流变性设计的专用螺杆和精密的计量泵系统和模具保证了熔体的均匀稳定和片材优异的光学性能；精密的压光系统给片材的机械物理性能提供了保障。产品主要应用于汽车工业；电子、电器工业的薄膜开关；电脑、手机、商务通的液晶显示屏；太阳镜、太阳帽、镀膜、防护面罩；特种印刷；医药包装等领域。

PC/PMMA Optical Sheet Extrusion Line To meet the demands of market, **JWELL** supply customer PC PMMA optical sheet extrusion lines with advanced technology, the screws are specially designed according to the rheological property of raw material, precise melt pump system and T-die, which makes the extrusion melt is even and stable and the sheet has excellent optical performance. Precise calender system guarantees the mechanical & physical properties of sheets. It is mainly used in automotive industry, film switch of electronics, LCD for computer, mobile, sunglass, helmet, special printing, medicine packing and so on areas.



主要技术参数 Main technical parameters

机型 Model	挤出机规格 Extruder model	制品宽度 Products width(mm)	制品厚度 Products thickness(mm)	设计挤出产量 Capacity(kg/h)
JWS100-1300	JWS100/38	1000	0.125-1.2	250
JWS120-1500	JWS120/38	1200	0.175-2	450

备注：以上规格参数如有变更，恕不另行通知。Note: The specifications are subject to change without prior notice.



ABS、HIPS、PMMA冰箱板、洁具板生产线 ABS, HIPS, PMMA Refrigerator Plate, Sanitaryware Plate Extrusion Line

ABS、HIPS、PMMA冰箱板、洁具板生产线

金纬机械提供国内领先的大产量低能耗板材挤出生产线，具备集中供料系统及机械手自动堆垛装置，实现了高程度的自动化生产功能，大大的降低生产成本并提高了产品品质。该生产线深受广大客户的欢迎。

ABS, HIPS, PMMA refrigerator plate, sanitaryware plate extrusion line

JWELL provides the leading plate extrusion lines with large output and low energy consumption, the lines are equipped with concentrated material feeding system and automatic piler, its automatic production function reduce the cost of processing and improve product quality highly. This extrusion line is popular in our customers.

冰箱板 Refrigerator board

主要用于冰箱冰柜门胆、内胆、抽屉、接水盘、饮水机等。

It has wide application in production of refrigerator door and inner gallbladder, drawers, water dispensers, etc.

洁具板 Sanitaryware plate

用于卫浴产品如：浴缸、淋浴房、蒸汽房、洗脸槽。

It is widely applied in the field of bath products, such as the bathtub, the shower cabinet, the vapor room, washing bowl, etc.

广告板 Advertising board

主要应用于：指示导向牌、胸标牌、机械标牌、广告装潢、室内装饰等。

This board is mainly used in guiding board, machinery sign, advertisement decoration, indoor decoration and so on.

箱包板 Baggage plate

主要用于各种拉杆箱、行李箱、休闲包等箱包。

It is mainly applied in field of draw-bar boxes, luggage cases, recreation bags, etc.

汽车板 Car plate

主要用途：汽车车顶、仪表板；座椅靠板、车门板、窗框；摩托车、沙滩车、代步车、高尔夫球车等外壳。

It is mainly used for producing tops of cars and buses, instrument boards, backrest, car doors, window frames, shells of the motorcycles, golf vehicles, etc.

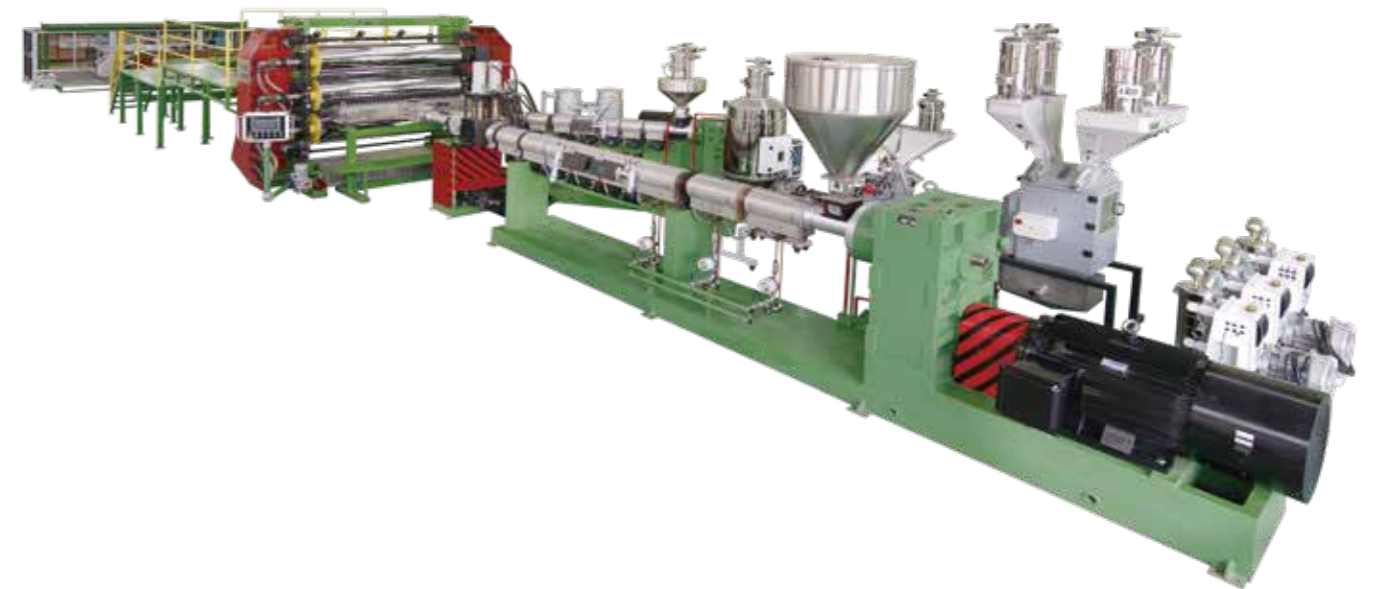

主要技术参数 Main technical parameters

机型 Model	JW160/60-2200	JW130/60-2000	JW120/60/45-1900	JW130/70/60-2700
适用原料 Suitable material	ABS、HIPS	ABS、HIPS	ABS、HIPS	ABS、PMMA
挤出机规格 Extruder model	JWS160/38,60/35	JWS130/38、60/35	JWS120/38,60/35,45/35	JWS130/38,70/35,60/35
共挤分层形式 Layer type	A/B,A/B/A	A/B,A/B/A	A/B/C	A/B/C/B/A
制品宽度 Products width	2000mm	1800mm	1700mm	2100-2500mm
制品厚度 Products thickness	1-6mm	1-6mm	1-6mm	2-8mm
最大挤出产量 Designed capacity	1500Kg/h	1200kg/h	550Kg/h	700Kg/h

备注：以上规格参数如有变更，恕不另行通知。Note: The specifications are subject to change without prior notice.

复合型高分子防水卷材生产线 High Polymer Composite Waterproof Roll Extrusion Line

适合多种物料的生产，包括PVC、TPO、PE等防水卷材；适合多种产品结构形式的防水卷材，包括：

均质卷材（代号H）：不采用内增强材料或背衬材料的防水卷材；

带纤维背衬卷材（代号L）：用织物如聚酯无纺布等复合在卷材下表面的防水卷材；

内增强卷材（代号P）：用聚酯网格布在卷材中间增强的防水卷材；

内增强卷材（代号G）：用玻纤网格布在卷材中间增强的防水卷材；

Used for different kinds of plastic material, such as PVC, TPO, PE etc. Being able to produce below sheets:

Plastic roll sheet (model: H): without coating with inner reinforced material or outer material.

Roll sheet with outer fiber (Model: L): coating with fiber or non-woven fabric.

Inner reinforced roll sheet (Model: P): Inner layer coats with polyester mesh.

Inner reinforced roll sheet (Model: G): Inner layer coats with glass fiber.

主要技术参数 Main technical parameters

机型 Model	SJZ92/188-SJZ80/156	SJP130/36-SJZ92/188	JWS150-JWS120
制品宽度 Products width	1200-2000mm	2000mm	2000mm
制品厚度 Products thickness	0.5-3.0mm	0.5-3.0mm	1-2mm
设计挤出产量 Capacity	800-900kg/h	1200-1300kg/h	1000-1100kg/h

备注：以上规格参数如有变更，恕不另行通知。Note: The specifications are subject to change without prior notice.

工艺流程 Processing diagram:

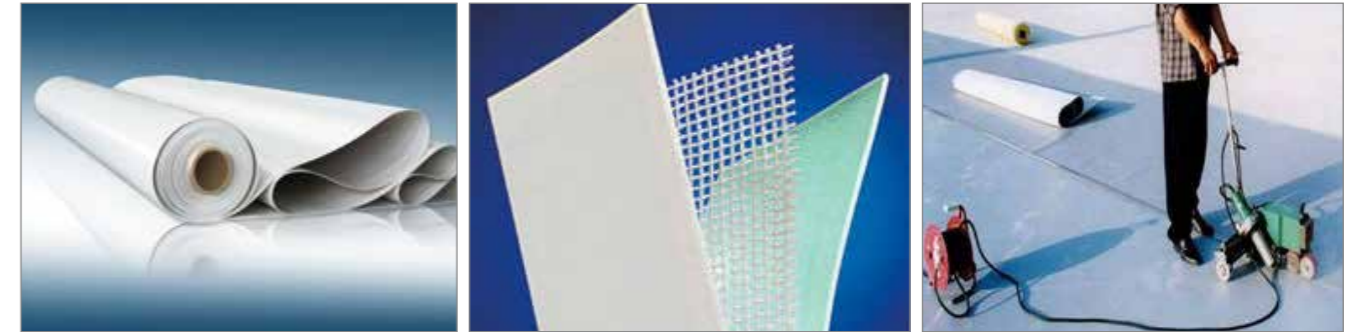
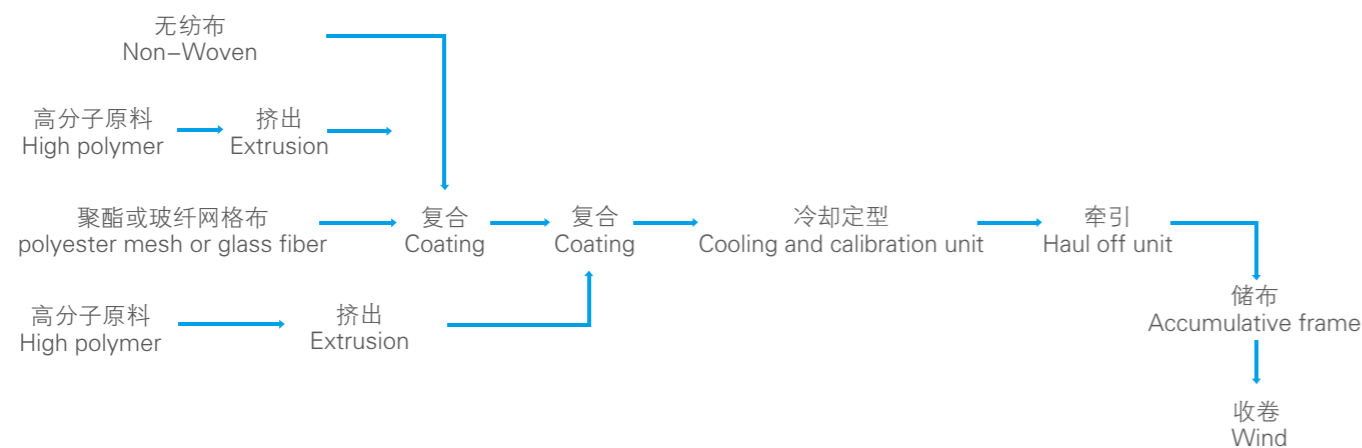

PE土工膜/防水卷材生产线 PE Extra-width Geomembrane/Waterproof Roll Extrusion Line

产品适用: 工业与民用建筑的屋面防水, 包括种植屋面、平屋面、坡屋面、建筑物地下防水: 包括水库、堤坝、水池防水、隧道、粮库、人防工程、垃圾掩埋场、人工湖防水等。

Application: For waterproofing usage in industrial & civil buildings including the green roof, flat roof and the sloping roof. Underground waterproof: reservoir, dam, pool. waterproof usage in tunnel, grain depot, artificial engineering, landfill, Artificial lake.

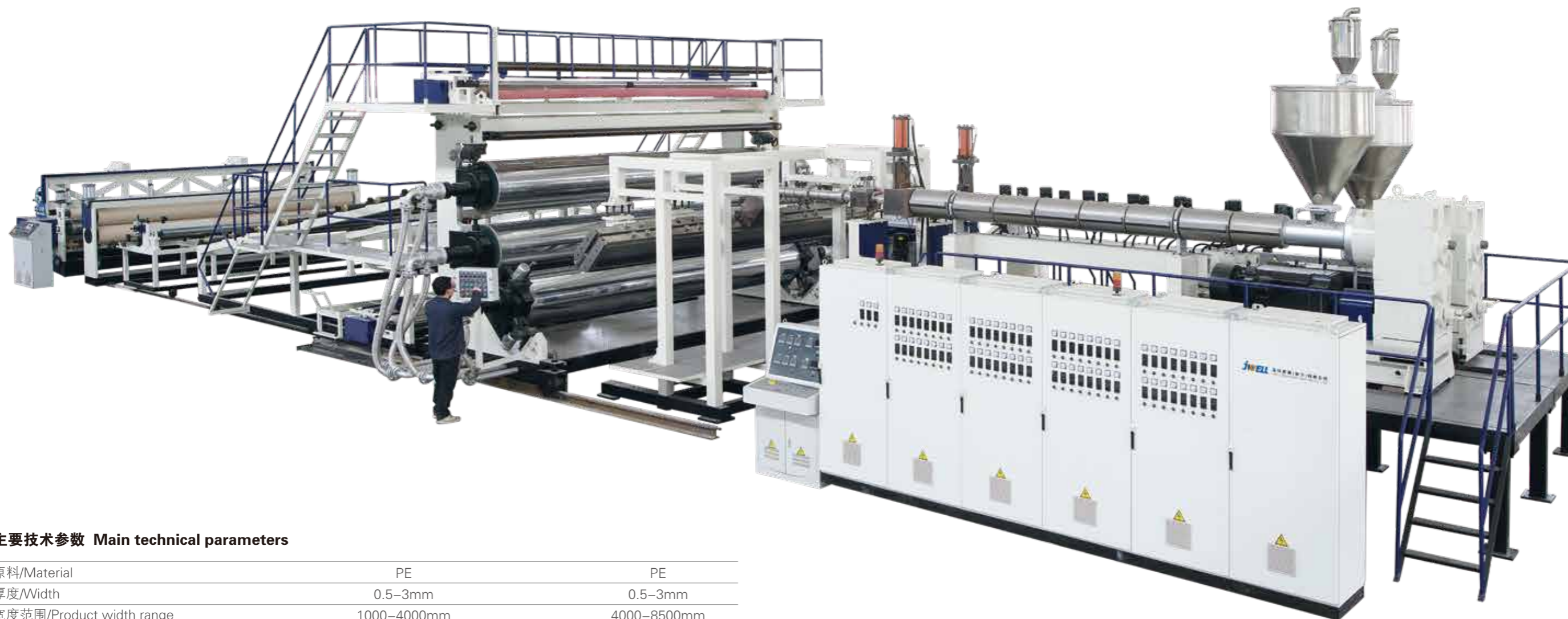

主要技术参数 Main technical parameters

原料/Material	PE	PE
厚度/Width	0.5-3mm	0.5-3mm
宽度范围/Product width range	1000-4000mm	4000-8500mm

备注: 以上规格参数如有变更, 恕不另行通知。Note: The specifications are subject to change without prior notice.

PC/PMMA/GPPS/ABS塑料片板材生产线 PC/PMMA/GPPS/ABS Plastic Sheet & Plate Extrusion Line

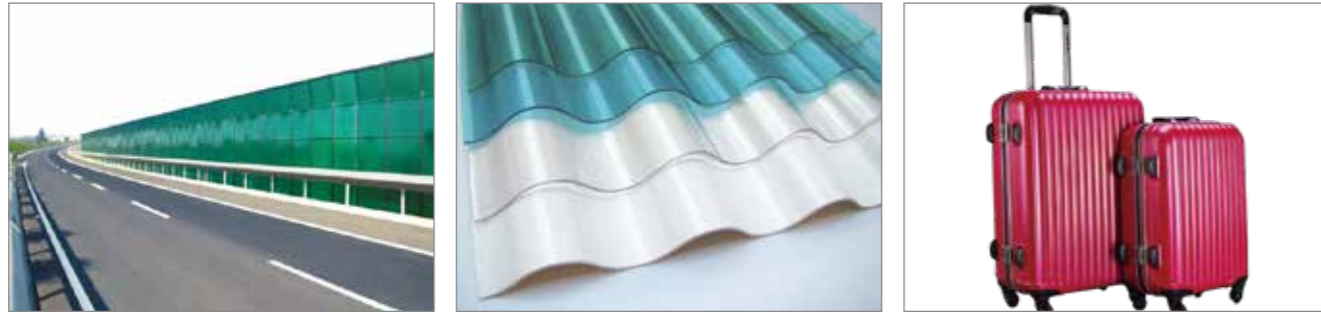

PC耐力板、波浪板:

适用范围: 园林、游艺场所奇异装饰及休息场所的廊亭; 商业建筑的内外装饰品, 现代城市楼房的幕墙; 航空透明集装箱、摩托车前风挡、飞机、火车、轮船、汽车、汽船、潜艇及玻璃军警盾牌; 电话亭、广告路牌、灯箱广告展示展览的布置; 高速公路及城市高架路隔音屏障。

Applicable scope of PC endurance board, PC corrugated sheet:

Garden, recreation place, decoration and the corridor pavilion; Internal and external ornaments in the commercial building, curtain wall of the modern urban building; transparent container of aviation, the windscreen before the motorcycle, the plane, the train, the steamer, the submarine, army and police's shield, the telephone booth, advertising signpost, the advertisement of the lamp houses, the expressway and overhead way of the city partition protective screen.

PMMA板材(亚克力板/GPPS板)

产品分类: 普通PMMA板材主要用于广告、装饰、装潢、工艺制品、标本标牌等; 电镀板用于真空电镀塑料镜片; 照明类导光板用于超薄灯箱、LED平板显示灯和海报架等广告装饰方面; 液晶类导光板用于电脑、电视等液晶显示组件。金纬提供的板材挤出生产线可用于加工PMMA或PC扩散板。

PMMA board (Acrylic board/GPPS board):

Application of product: common PMMA plate is mainly used in the field of advertisement, decoration, art ware, escutcheon and specimen etc; the electroplated plate is used for plastic mirror; Light panel is used for ultra light box, flat panel display lamp of LED, poster stand and advertising decoration etc. LCD panel can be used for the display of computer and television. JWELL'S plate extrusion line is suitable for producing the PMMA or PC diffusion plate.



主要技术参数 Main technical parameters

型号 Model	JWS130/38-2200	JWS120/38-1400
适用原料 Material	PC, PMMA, GPPS, ABS	PC, PMMA, GPPS, ABS
制品宽度 Products Width	2200mm	1400mm
制品厚度 Products Thickness	1.5-10mm	1.5-10mm
挤出机规格 Extruder Specification	Ø130/38; Ø45/30	Ø120/38
最大挤出产量 Capacity (Max.)	550Kg/h	450Kg/h

备注: 以上规格参数如有变更, 恕不另行通知。Note: The specifications are subject to change without prior notice.

PVC透明硬片/PVC装饰片生产线 PVC Transparent Sheet and Rigid Sheet Extrusion Line

PVC挤出透明硬片生产线

PVC挤出透明片材具有阻燃自熄、质优价廉、透明度高、表面光泽好、晶点少、水纹小、耐冲击性强且易于成型等特点, 广泛应用于各类工具、玩具、电子、食品、医药、服装等行业的吸塑、折盒、包装等。

PVC transparent rigid sheet extrusion line

PVC transparent sheet have many advantages of fire-resistance, high quality, low cost, high transparent, good surface, no spot, less water wave, high strike resistance, easy to mould and etc. It is applied to different kinds of packing, vacuuming and case, such as tools, toys, electronic, food, medicine and clothes.

PVC装饰片生产线

PVC装饰片主要用于酒店、餐馆、办公室、厨房灯地方的内外墙装饰。

PVC decoration plate line:

Product application: For decoration in hotel, restaurant, office, inner wall of villa, kitchen, toilet and it can be used or outside wall decoration, ceiling, table cloth, flooring and etc.



主要技术参数 Main technical parameters

机型 Model	挤出机规格 Extruder model	制品宽度 Products width(mm)	制品厚度 Products thickness(mm)	主电机功率 Main motor power(kw)	设计挤出产量 Designed extrusion output(kg/h)
SJZ80/156-1500	SJZ80/156	1220	0.2-3.0	75	350
SJZ92/188-2200	SJZ92/188	2000	1.0-3.0	110	550

备注: 以上规格参数如有变更, 恕不另行通知。Note: The specifications are subject to change without prior notice.



PP/PE/ABS/PVC厚板生产线 PP/PE/ABS/PVC Thick Plate Extrusion Line

PP厚板生产线 PP thick plate extrusion line

PP厚板，可广泛用于化学工业、食品行业、防腐行业、净化行业、环保设备生产行业。
PP thick plate, is an environmentally-friendly product and is widely applied in chemistry industry, food industry, anti-erosion industry, environmentally-friendly equipments industry, etc.

2000mm宽PP厚板生产线是金纬新开发的领先于同行的稳定的生产线。
PP thick plate extrusion line of 2000mm width is a newly developed line which is the most advanced and stable line compared with other competitors.

PE厚板生产线 PE thick plate extrusion line

聚乙烯 (PE) 板材广泛应用于化工、电力等工业上。HDPE板还可作为工程塑料应用在机械、化工等设备上，广泛用于制造冰球场墙板。
PE plate is widely applied in chemical and electric power industries. HDPE plate, known as engineering plastics, is used in mechanical and chemical equipments as well as ice hockey ring walls.

ABS厚板生产线 ABS thick plate extrusion line

ABS厚板广泛应用于家电、电子、包装、医疗器械等领域。
ABS thick plate is widely used in the home appliance, electronics, packaging, medical appliance.

PVC厚板生产线 PVC thick plate extrusion line

硬质PVC厚板广泛用于化工、石油、电镀、水净化处理设备、环保设备、矿山、医药电子、通讯、防腐蚀容器、设备电气的护罩，灯箱，广告装潢等行业。
Rigid PVC thick plate is widely used in chemical industry, petrol, electroplating, water purifying equipments, environment-friendly equipments, lamp house and advertisements, etc.

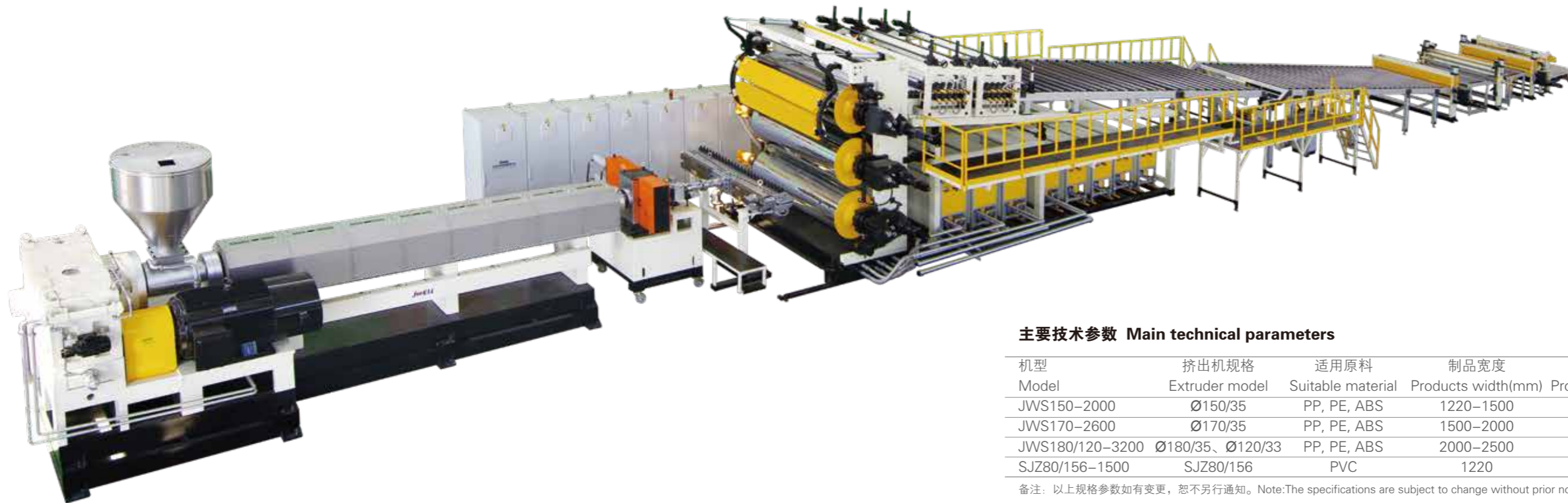

主要技术参数 Main technical parameters

机型 Model	挤出机规格 Extruder model	适用原料 Suitable material	制品宽度 Products width(mm)	制品厚度 Products thickness(mm)	设计挤出产量 Capacity(kg/h)
JWS150-2000	Ø150/35	PP, PE, ABS	1220-1500	3-30	500
JWS170-2600	Ø170/35	PP, PE, ABS	1500-2000	3-30	700
JWS180/120-3200	Ø180/35、Ø120/33	PP, PE, ABS	2000-2500	3-30	1200
SJZ80/156-1500	SJZ80/156	PVC	1220	3-30	450

备注：以上规格参数如有变更，恕不另行通知。Note:The specifications are subject to change without prior notice.

其他特殊的塑料片板生产线 Other Plastic Sheet And Plate Extrusion Line

PVC/ABS宽幅封边条生产线 PVC/ABS edge sealing extrusion sheet line

该系列生产线采用一步法生产工艺，具有生产效率高，控制精确，能耗低等特点；可替代PVC压延片，广泛用于家具、办公用品的贴面、封边、包装吸塑等。

This series extrusion line adopts one-step type production process, with high production efficiency, accurate control and low energy consumption. The products can replace PVC calendaring sheet, widely used in furniture, office appliances veneer, edge sealing, packaging blister, etc.



XPE/IXPE母片生产线 Extrusion sheet line for xpe/ixpe foaming

此系列生产线作为XPE/IXPE发泡生产的前道工序，采用金纬独特的螺杆结构设计，配套镜面辊压光成型，具有操作简单、设备稳定、片材厚度均匀等特点；产品被广泛用于爬爬垫、瑜伽垫、运动器材减震等。

As the first procedure of XPE/IXPE foaming production, this series production line adopts the unique screw structure design of Jwell, supporting mirror roller pressing molding, with easy and stable operation, uniform sheet thickness and other characteristics. The products are widely used in baby crawling mat, yoga mat, sports equipment shock absorption, etc.



PE铜塑复合片材生产线 Copper-plastic composite extrusion line

复合型导电高分子是在本身不具备导电性的高分子材料中掺混入大量导电物质，如炭黑、金属粉、箔等，通过分散、表面铜皮复合等方法构成的复合材料。广泛用于正温度系数热敏电阻（PPCT）、新能源锂电池行业等。Composite conductive polymer is a kind of composite material which is composed by dispersion method and copper skin composite method by mixing a large number of conductive materials, such as carbon black, metal powder, foil, into the polymer material which is not conductive itself. The products widely used in positive temperature coefficient thermistor, new energy lithium battery industry, etc.



实验室级片材薄膜生产线 Lab-grade sheet&film extrusion line

TPU/EVA医用膜，用于输液袋、血浆袋、伤口敷料等；TPU/PETG牙片，用于牙齿整形；PE隔离膜，防护服。

TPU/EVA medical film, For infusion bag, plasma bags, wound dressing and so on; TPU/PETG SHEET, For orthodontics; PE isolating membrane, For protection suit.



PE蓄电池隔板生产线 PE battery separating plate extrusion line

隔板蓄电池的重要组成部分，PE隔板是蓄电池隔板的换代产品，随着我国汽车行业发展及普及，PE隔板市场将进一步扩大。

It is an important part of battery. PE separating plate is a new style of battery separator. With the development of car industry in China, the market share of PE separating plate will be greatly increased.



塑料土工格栅生产线 Plastic geogrid extrusion line

产品广泛应用于水利、公路、铁路、煤矿、建筑等工程领域。如用于建坝、护坝、护坡，防汛防洪网笼，高速公路、铁路、路基加固，挡土墙护网、矿井顶网，由于在工程应用中表现出的优越性能，以及产品低成本、高效率的特点，市场前景广阔。

It is widely used in irrigation, highway, railway, mine and building project, for example it's used to build dam, protect dam and slope, protect network of preventing flood, fix the roadbed and etc. The product has a high perspective among the markets because of its effective features.

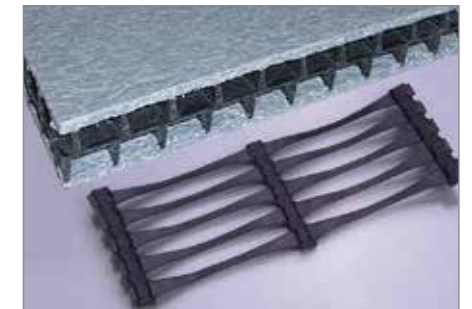

钢材钢卷防锈用PP、PE塑料包装板材生产线 PP, PE plastic packing plate for rust prevention of iron and steel extrusion line

钢卷包装用塑料端护板。塑料保护板、端护板、内外护角圈、端护圈、包装盒、垫片等。金纬也可以提供钢材包装专用三层共挤PE/PP发泡板材生产线。

Protection board for steel roll packing. Plastic protection board, terminal protection board, inside and outside angle protection ring, terminal protection ring, packing case, gasket and so on. Jwell can provide three-layer co-extrusion PE/PP foaming board production line only for steel packing.



PP发泡片材生产线 PP foam sheet extrusion line

聚丙烯PP发泡片材是采用物理发泡工艺，发泡倍率达到1-8倍，它具有轻质、隔热、隔音、缓冲防震，是一种绿色环保材料，可广泛应用于制作文具、食品包装、电子材料、装饰材料以及汽车装饰板等行业。

Polypropylene (PP) foam sheet use the physical foam process, foam ratio reach 1-8 times, it has light weight, heat insulation, sound insulation, cushion, is a kind of green environmental protection material, which can be widely applied in the stationery, food packaging, electronic materials, decoration materials and automobile decorative, etc.



相关部件产品链接 Other Component

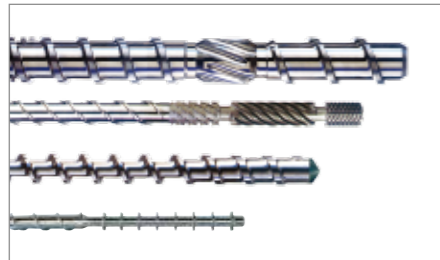

螺杆机筒 Screw&Barrel

金海螺品牌始创于1978年，40年的螺杆机筒专业制造经验和历程，是产品质量的有效保障。可以提供单螺杆、双螺杆机筒和客户特殊定制。

Founded in 1978, JHL is China's best screw brand. 40 years of professional experience in the production of screw barrels and processes is an effective guarantee of product quality. Single-screw, twin-screw barrels and special customized designs are available.



辊筒 Roller

适用于各种板、片、膜生产的镜面辊、花纹辊等，控温精度高，温差小，保证了制品的冷却，产品厚薄均匀度优秀。

Suitable for manufacturing of all kinds of plate, sheet, film with mirror face or embossing. It has good temperature control and minimized difference, which ensure the product cooling and result in good thickness tolerance.



模具和分配器 T-Die and feedblock

使用优质牌号模具钢，经过进口高精密度机床加工，3D熔融流体模拟流道，制品品质有保证，使用寿命长，为各种产品定制化设计。

Use high-quality mold steel, adopt imported high-precision machine tool processing, 3D melt fluid simulation runner, product quality is guaranteed, long service life, customized design for various products.



多组分喂料系统 Multi component feeder

挤出工艺时采用组分计量喂料设备，可最大程度节约原料消耗，减少开机废品，控制精度低于±0.3%，减少人工成本。

When multi components feeder is used in extrusion line, it can save raw material consumption to the greatest extent and reduce boot waste. The control accuracy is less than ±0.3%, minimize labour cost.



破碎机 Crusher

破碎回收的机头废料和试生产中产生的非常规制品。有不同用途和规格的破碎机可供选择。

Shredding scraps during the production of startup and unconventional products produced during trial production. There are crushers with different uses and specifications to choose from.

长期合作品牌 Long-term Cooperation Brand

